



# Industrial Products Distributor

Engaged in Project Selling.



**Construction**



**Industrial**



**Infrastructure**



**Institutional**

# INDEX

---

<b>1. About Us</b>	<b>1</b>
2. Civil Infrastructure	2-5
<b>3. Potable Water Works</b>	<b>6-7</b>
4. Waste Water Solutions	8-9
<b>5. Irrigation &amp; Landscaping</b>	<b>10-11</b>
6. Fire Fighting	12-13
<b>7. MEP Supplies</b>	<b>14-15</b>
8. Construction Specialities	16-17
<b>9. Building Technology Solutions</b>	<b>18-19</b>
10. Water Treatment	20-21
<b>11. Oil and Gas</b>	<b>22-23</b>
12. Instrumentation	24-25
<b>13. Electrical</b>	<b>26-27</b>
14. Science & Technology	28-29
<b>15. Our Presence</b>	<b>30</b>

# ABOUT US

Dutco Tennant LLC is a trusted provider of solutions for construction, industrial, and infrastructure projects across the Middle East. As a key entity within the diversified Dutco Group, we leverage decades of experience, deep technical expertise, and strong global alliances to deliver value-driven results.

We proudly serve as a leading distributor for renowned international manufacturers and suppliers, offering dependable technologies and customized solutions tailored for our clients project needs.

## MISSION

We are dedicated to provide world class solutions to our customers to fulfill their diverse needs through a team of experienced and qualified professionals who are recognized for what they do.

We are a technology management company with a futuristic outlook and a keen desire to learn and change with the times.

Our commitment to the customer is of prime importance to us in building enduring relationships with them.

## CORE VALUES

We believe that **OPENNESS, INTEGRITY AND HUMILITY** are the cornerstones for the success of our business in dealing with our internal and external environment.

We believe in nurturing an environment which instills a feeling of ownership and allow people to deploy their **ENTREPRENEURIAL SKILLS**.

We recognize that the **RESPECT** we have for our people and the **FREEDOM** we give, transforms them into being **RESPONSIBLE** and **ACCOUNTABLE** for their actions.

We strive to provide an environment of job security and accessibility by being sensitive to the needs of each other.



# Civil Infrastructure



Dutco Tennant LLC, based in Dubai, UAE, is a leading provider of comprehensive solutions for construction, technology, and civil infrastructure across the Middle East. With over 40 years of experience, we have played a key role in shaping communities by delivering smart, sustainable solutions for landmark projects, including roads, ports, airports, and large commercial developments. Our commitment to innovation and quality ensures we meet the evolving needs of our clients, contributing to the region's growth and development.

## 1 Bridges



Bridge Bearings



Bridge Expansion Joints



Bridge Parapets

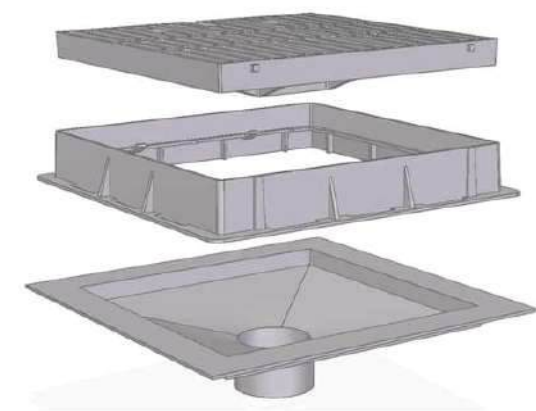

Bridge Scuppers

## Landscape & Irrigation

2

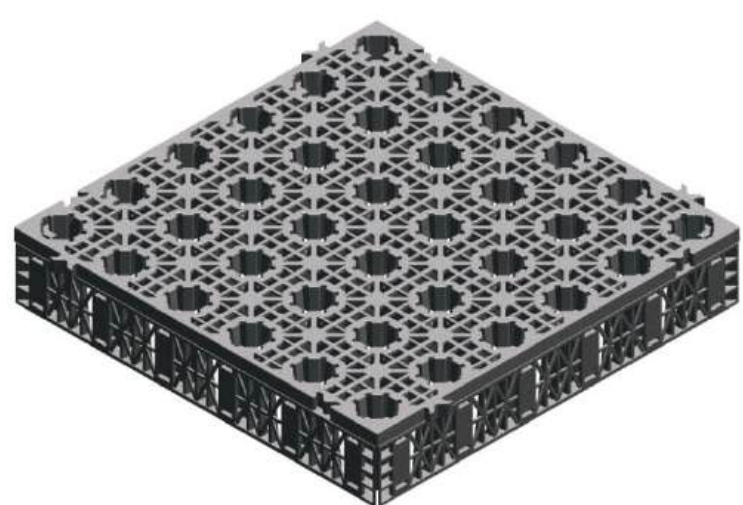

Drainage Cell (Nerovoid)



Salt Barrier / Weed Barrier



Steel And Aluminium Garden Edges



Grass Paver

## 3 Roads & Utilities

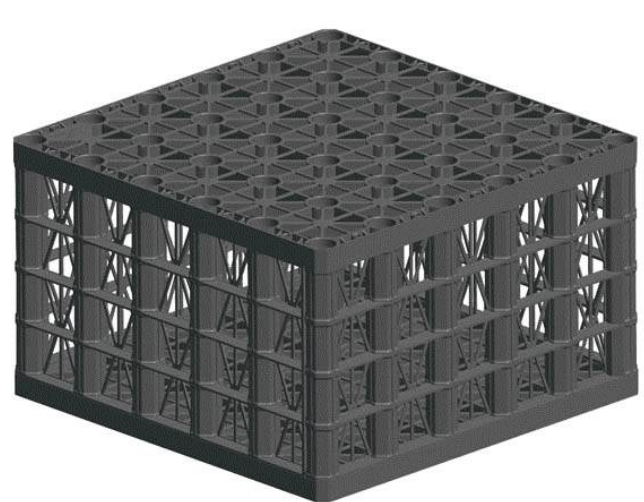

Soakaway Boxes / Infiltration Tanks



Geotextile And Geogrid



Warning Tapes & Cable Tiles



Access Chamber



## 4 Road Safety



Crash Cushions



Guard Rails And End Terminals



Temporary Barriers



Gabion Mesh & Mattress

## Erosion Control & Soil Stabilization 5



Dust Control & Suppression



Erosion Control



Geocell

## 6 Ductile Iron Castings



Manhole Covers



Channel Gratings

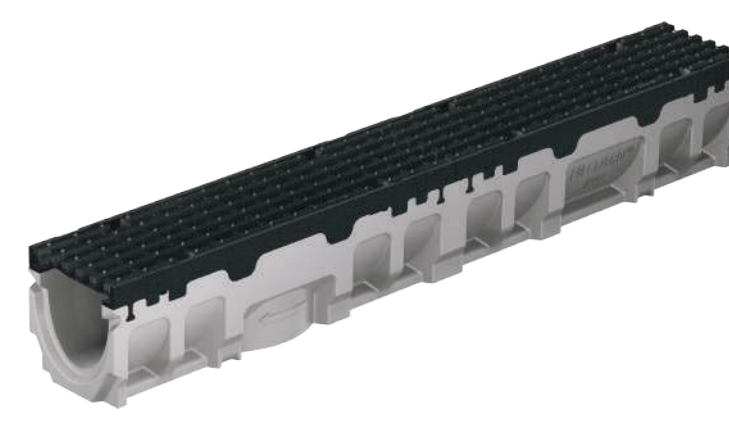

Trench Drain

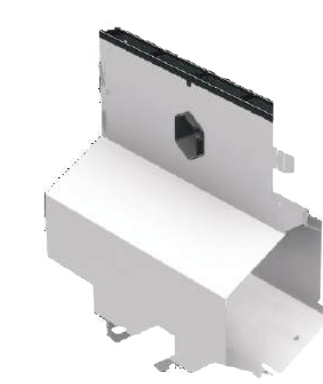

Slot Drains



## 7 Surveying Products



Leica NA2 & NAK2  
Automatic, Optical Levels



Leica TS16: Robotic  
Total Station



Leica RTC360  
3D Laser Scanner



FLEX Concrete  
Scanner GPR

## Road, Infrastructure, Pipe Line, Bridge, Landscape 8



Leica GS18 I GNSS  
RTK Rover



Leica FlexLine TS10  
Manual Total Station



UtilityScan DF



DXL3 Cable  
Avoidance Tool

## 9 Marine, Oil & Gas, Quarry



Leica Nova MS60  
MultiStation



Leica GS18 T  
GNSS RTK Rover



Terrestrial Laser  
Scanner



## Traffic Products

10



Traffic Signal Heads

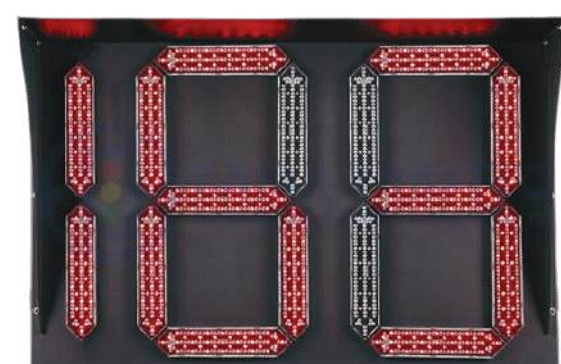

Vehicular Count Down Timer



Solar Traffic Signal Heads



Traffic Controller



Priority System



INVIPO Traffic Integration System

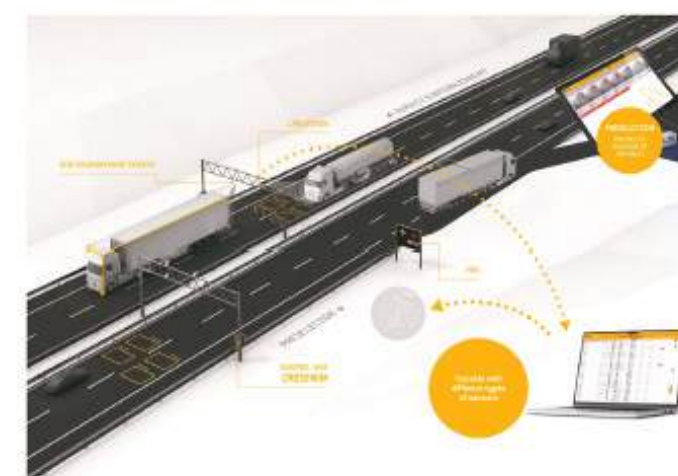

Weigh In Motion System



UPS- Uninterrupted Power Supply

## 11 Digital Twinning and Operational Technology (OT) Cyber Security



Command Center Solutions

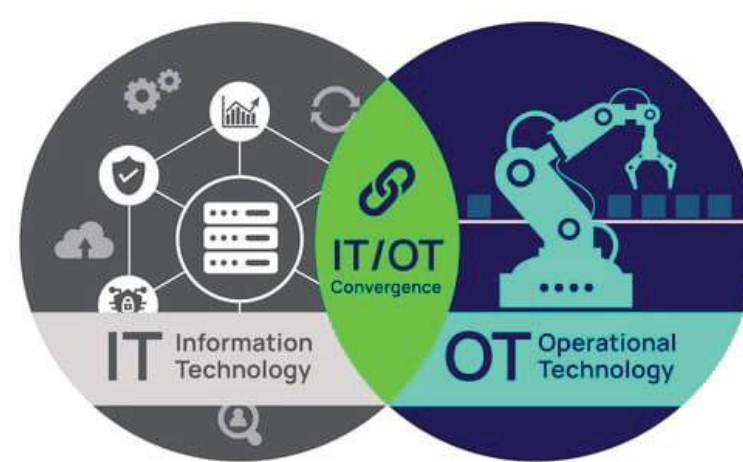

Cyber Security Solutions / OT



PanoRM 360



# Potable Water Works



Water is one of the most basic and important resources to support human life and the ecosystem. Poor water resource management is a big hindrance to the development of human society. We at Dutco Tennant LLC believe that arranging for clean, hygienic and pure water for everyone should be a great priority for all the countries, and that can be achieved by ensuring secure access to water resources, protecting destructive use of water, and ensuring consistent provision of affordable, potable water. For around four decades, Dutco Tennant LLC has been involved in supplying various potable water components for potable water projects. Our specialty lies in supplying high-quality potable water valves and other equipment that meet the exact project requirements and are designed to meet the stringent regulatory requirements and government standards.

## 1 Potable Water Transmission Lines, Distribution Lines, Pumping Station & Reservoir



Gate Valves



Butterfly Valves



Air Valves



Check Valves



Needle Valves



Hydraulic Control Valves



Flange Adapters & Couplings



Dismantling Joints



Rubber Expansion Joints



House Connection Fittings



Modular Seals



Prefabricated Chamber



## Miscellaneous Products

2



Quick Coupling



Air vent



Handle Bar



MS Clamp



Marker Plates



Flexible Indicator Posts



# Wastewater Solutions



Dutco Tennant LLC specializes in providing cutting-edge sewage and drainage solutions for the Middle East and GCC, addressing the region's wastewater challenges. We offer tailored solutions for wastewater, sludge, and waste management. As the natural water resources are getting depleted, and water is becoming scarce and more luxurious, world faces the problem of natural calamities like global warming and climate change, with disastrous penalty for humanity. Irrespective of the size and nature of the project, if you are looking for superior, more economical and more dependable sewage water products, then please get in touch with us. We provide a complete range of machines and equipment for the wastewater, process water, and grit and sludge. Our machines and equipment are constructed from high-quality, durable, and corrosion-resistant materials, ensuring the highest quality for our customers.

## 1 Municipal Sewage Treatment Plants & Networks



Penstock & Stop Logs



Screening Equipments



Screw Conveyor & Compactor



Grit Removal System



Oil Skimmer  
(Fog & Scum Removal)



Odor Control Unit



Self Cleaning Filter



Telescopic Valve

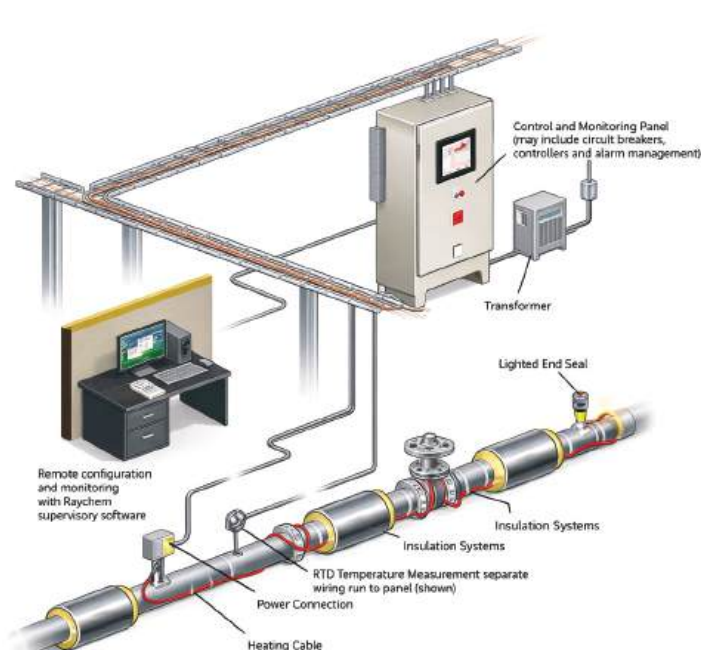

Heat Tracing



## Municipal Storm Water Pumping Stations & Network

2



Pump



Flange Adaptor,  
Dismantling Joint &  
Coupling



Sewage Air  
Release Valve



Double Eccentric  
Butterfly Valve



Meta Seated  
Gate Valve



Surge Vessels



Hydrodynamic  
Sperator



Duckbill Check  
Valve

3

## Industrial Wastewater Treatment



Aerators & Mixers



Macerator

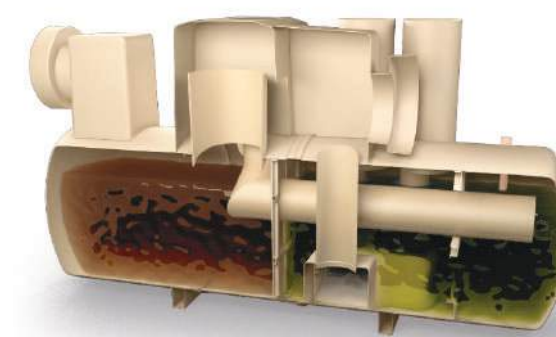

Oil Sperator



Vortex Drop Shaft

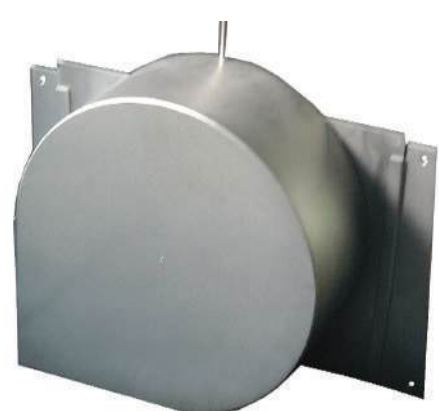

Vortex Flow Control



Plug Valve



Inflatable Pipe Plug  
& Stopper



Flap Valve



# Irrigation And Landscaping



Purity, supply, and management of water are crucial for success in the irrigation and landscaping industries, so if you're seeking for answers, you must grasp this. Our irrigation and landscaping solutions, including pumps, mixers, irrigation gate valves, backwater valves, and other water handling systems, have been designed to irrigate every part of your fields. No matter where you are in the world, these products are resilient in the harshest conditions and support the success of your agricultural operations. The Middle East and the GCC region are the primary geographic areas we serve. The following are some of our most well-liked irrigation & landscaping items.

## 1 Landscaping



Dripline & Fittings



Flange Adaptor, Coupling & Dismantling Joint



Basket Strainer



Solenoid Valve



Quick Coupling Valve



Irrigation Controller

## Irrigation & TSE 2



Gate Valve / Air Valve



Butterfly Valve



Flange Adaptor / Dismantling Joints / Coupling



Self Cleaning Filters



Check Valve



Water Meter



Control Valves



Diaphragm Control Valve



Basket Strainers



DI Pipes



Penstock

### 3 Agriculture



Greenhouse - Polycarbonate Sheet



Climate Control System



Hydroponics System



Driplines



Fertigation Systems



Humidifiers



# Firefighting Products



We at Firefighting Products Division strive to enhance and support the efforts of independent fire sprinkler designers and contractors with our comprehensive, integrated solutions for any fire protection challenge. We believe that protecting people and property from fire is a social commitment with a purpose that transcends the bottom line. Our professional approach to this end gives us an edge that sets us apart in the Middle East as a reliable partner for a safer tomorrow.

We at Firefighting Products Division continually improve our product offering by introducing new products and enhancing existing designs to suit market needs. Our complete line of firefighting products provide you with the reliability you need backed by the guarantee that is offered by the world renowned manufacturers we represent in the region. Our collective knowledge on top-of-the-line products one excellent, single source solutions that persistently raise the bar for the fire protection industry.

## 1 Sub Stations & Power Plants



Fire Water Tanks



GRP Tanks



Fire Alarm Panel



Fire Hydrants-Wet Barrel



VESDA System

## Buildings 2



Fire Alarm Panel And Devices-Notifier



Fire Alarm Panel And Devices -Esser



VESDA System



Valves- Gate Valve



Valves- Butterfly Valve



Valves- Check Valve



Pressure Reducing/ Relief Valves



Mineral Insulated Cables



GRP Tanks



Fire Alarm Panel & Devices -Morley



Fire Alarm Panel & Devices-Farenhyt



### 3 Infrastructure & Pumping Station Networks



Fire Alarm Panel And Devices -Notifier



Fire Hydrants- Dry Barrel



Air Valve



Pipes & Fittings

### Industrial Units, Warehouses & Fuel Stations 4



Fire & Potable Water Tanks



Fire Alarm Panel & Devices -Notifier



Fire Alarm Panel & Devices -HS 81



Pipes & Fittings



VESDA System



Mineral Insulated Cables



Valves- Gate Valve



Valves- Butterfly Valve



Valves- Check Valve

### 5 Oil And Gas



Fire Alarm Panel And Devices -HS 81



Gas Detectors



Flame Detectors



VESDA System



# MEP Supplies



Our MEP Supplies Division provides top-tier Mechanical, Electrical, and Plumbing solutions in the UAE. We offer premium valves for chilled water and plumbing systems, ensuring optimal flow and efficiency. Our durable drainage solutions and precise BTU and water meters cater to both residential and commercial needs. Specializing in district cooling, we supply essential valves and accessories, all sourced from renowned global manufacturers for exceptional performance across various projects.

## 1 Plumbing & Chilled Water Products



Iron Valves



Bronze Valves



Balancing Valves



Pressure Reducing Valves



Flexible Connectors

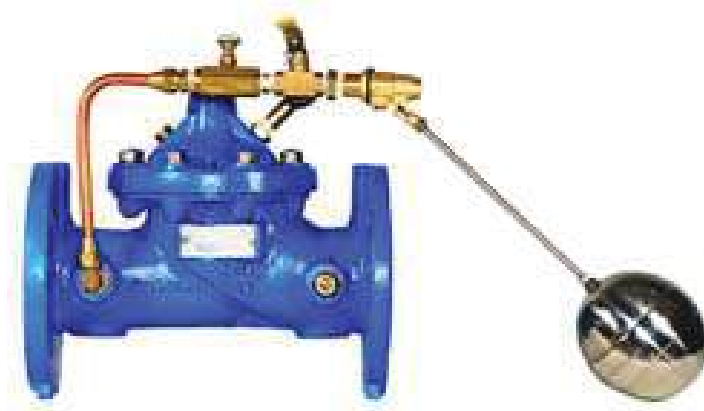

Float Valves



Water Hammer Arrestors



Backflow Preventors



Thermostatic Mixing Valves



PICV

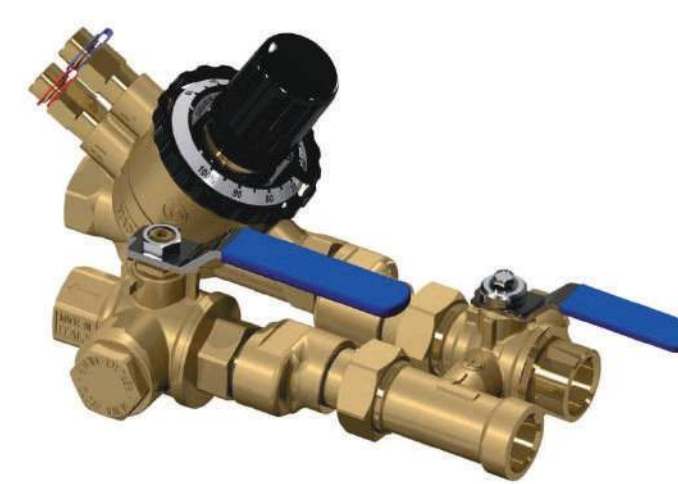

Hook Up Kits



Chilled Water Pumps



Drains



Manhole Covers



## Building Controls

2



BTU Meters



Water Meters



Leak Detection System



Smart Valves



Thermostats



Smart Energy Valve

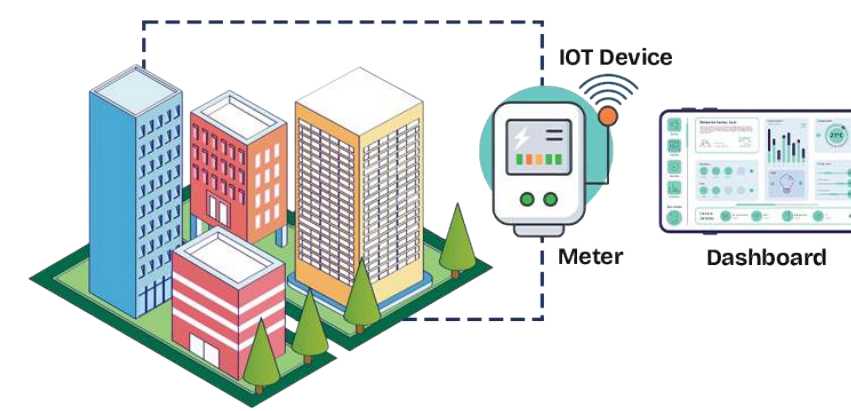

Energy Management Solutions

## 3 District Cooling



Process Butterfly Valves

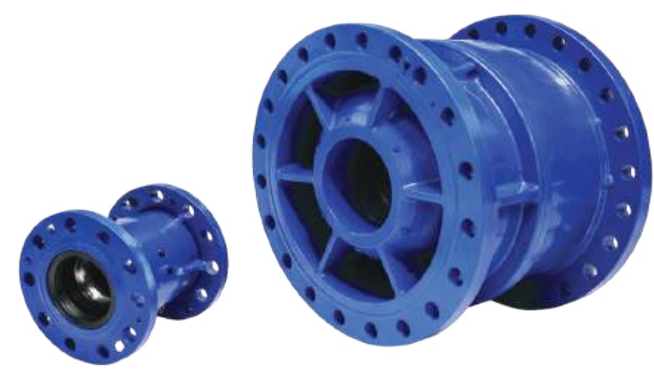

Nozzle Check Valves

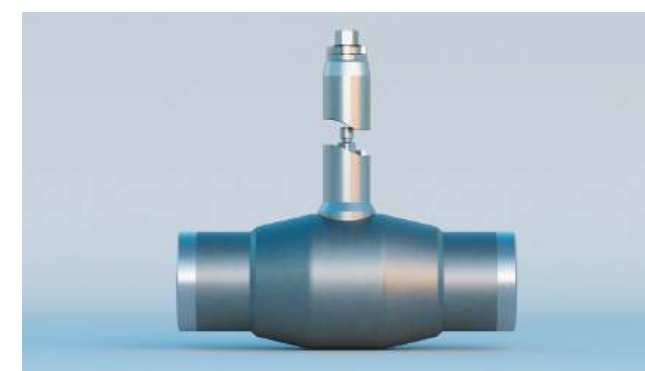

Buried Ball Valves



Suction Diffusers



Penstock



Dismantling Joints



Expansion Joints



Electromagnetic Flow Meter



# Construction Specialities



The Construction Specialities Business specializes in aesthetic building solutions, including raised flooring, commercial carpets, luxury vinyl, and acoustics. We provide expansion joints, entrance matting, and roofing products. We also offer seating solutions for airports and auditoriums. Our range includes access panels, tile trims, and wall protection systems, serving the healthcare, hospitality, and commercial sectors.

## 1 Flooring Products



Raised Access Flooring



Carpet Flooring



Vinyl Flooring



Entrance Matting System

## Architectural Finishing Products 2

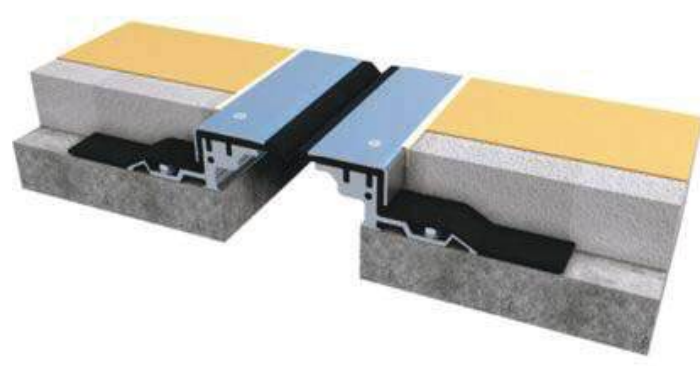

Expansion Joints

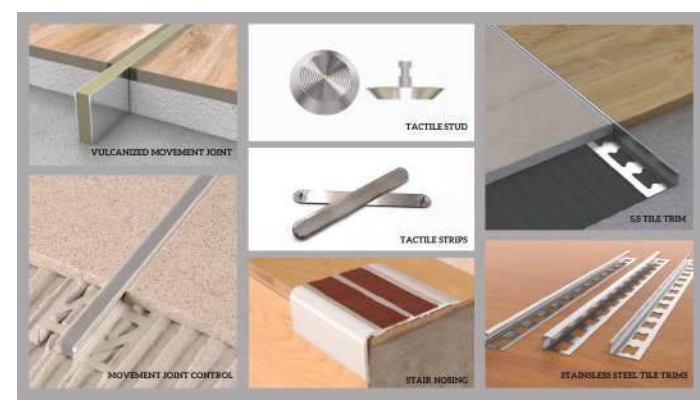

Finishing Profiles



PVC Wall Protection System



FRP Wall Protection Panels



Roof Hatch & Ladder



Fire Rated Access Panels



Fire Rated Smoke Vent



Floor Hatch

## 3 Acoustic Solutions



Plaster Ceiling



Spray Ceiling



## Roof Tile Solutions

4



Asphalt Roofing Shingles



Metal Roofing Tile

5

## Light Fixtures



Indoor Spotlights



Surface Luminaires



Landscape Lighting



Modular Lights

## Locks & Lockers/Seating Solutions

6



Smart Locker Solution



Digital Locks



Auditorium Seating



Telescopic Seating

7

## Partition



Operable Partition



Glass Wall Partition



# Building Technology Solutions



We supply Building Technology Solutions (BTS) from leading global brands, offering a wide range of interoperable and complementary products/services. Our expert team delivers tailored solutions to meet client needs. We ensure to accomplish project success through strong relationships with clients and partners. Furthermore, our consulting and professional services define and implement effective strategies, supported by decades of experience and global expertise.

## 1 Life Safety

Notifier By Honeywell | Farnelyt By Honeywell | Esser By Honeywell | Morley By Honeywell | Scame By Honeywell | Xtralis By Honeywell | X618 by Honeywell | Variodyn By Honeywell | Intevio By Honeywell | Lithium Ion Tamer By Honeywell



Fire Alarm & Air Aspiration System



Central Monitoring Of Self Contained Emergency & Exit Lights



Public Address & Voice Alarm System



Lithium Ion Detection



Disabled Toilet & Refuge Alarm System

## Building Automation 2



Intelligent Lighting Control



Home Automation



Guest Room Management



Building Management System

## 3 Data Center



Server Racks ,UPS Systems, Busway System, Hot Aisle Containment, Battery Monitoring System, Liquid Cooling& Solutions & PDUs



Racks & Cabinets, Hot Aisle Containment , Outdoor ELV Cabinets With Cooling & Basic PDU, Environmental Monitoring System EMS & Battery Monitoring System, Leak Water & Fuel Detection Systems



Water & Fuel Leak Detection System

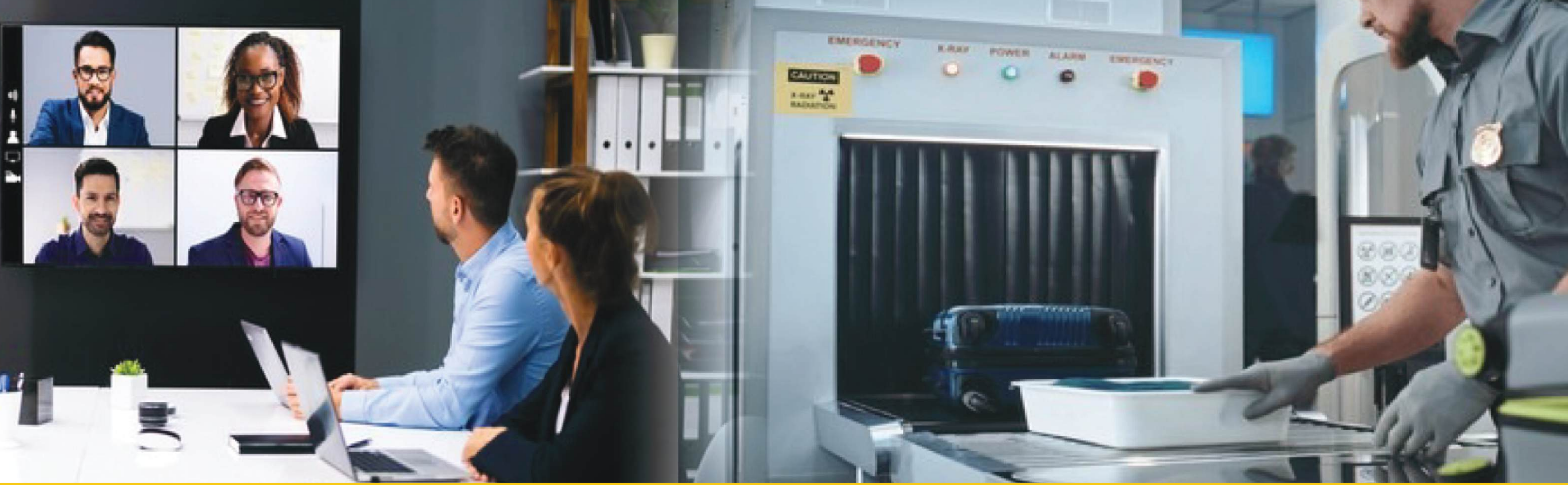

## Audio Visual (A/V)

4



Video Conferencing  
Cameras & Systems,  
Professional PTZ  
(pan-tilt-zoom) Cam



Audiovisual  
Automation,  
Control, & Integration  
Technology



Pro AV  
Connectivity  
& Distribution



Wireless Presentation,  
Wireless Display,  
& Collaboration  
Solutions



Digital Display &  
Commercial  
AV (Audio-Visual)  
Solutions

5

## ELV & Security – Projects & Distribution



X-Ray Baggage Scanners



Metal Detectors



Road Blockers, Sliding, Swing &  
Folding Gates, Turnstiles,  
Bollards ( Fixed & Hydraulic)



Digital Signage



UPS



Master Clock

## System Integration / Services

6



Structured Cabling  
System



Electronic Security  
Systems (CCTV, Access  
Control, SMS, PSIM)



Audio Visual  
System



Building Intercom



Converged ICT  
Network Solution



# Water Treatment



We delivers effective and sustainable solutions for water and wastewater treatment across the Middle East. Our portfolio includes filtration systems, reverse osmosis, disinfection units, chemical dosing systems, and packaged treatment plants. We work with globally recognized manufacturers to provide high-performance technologies, supported by expert service, maintenance, and tailored project solutions that meet diverse client requirements.

## 1 Water Treatment Products



Hydranautic-Membranes



Genesys-Membrane Antiscalant



Pulsafeeder-Dosing Pump



Pentair-Structural Tank



Pentair-Codeline Pressure Vessel



Dryden Aqua-Media Filter



Thermax- Chemical



## Water Treatment Package Plants

2



Multi Media Filtration System



Skid Mounted Reverse Osmosis (RO) System



TSE Polishing Plant



Effluent Treatment Plant



Effluent Treatment Plant



Containerized Rental RO



Sewage Treatment Plant



Ultra Filtration



# Oil & Gas



We deliver end-to-end solutions for offshore and onshore exploration, production, and processing. Our portfolio includes high-performance piping systems, precision-engineered valves, corrosion-resistant fittings, and custom fabrication-globally sourced and locally stocked to keep your operations efficient and reliable, wherever the field may be.

## 1 Pipeline Products/ Accessories



Heat Shrink Sleeves



Epoxy Based Systems



Cold Applied Tapes

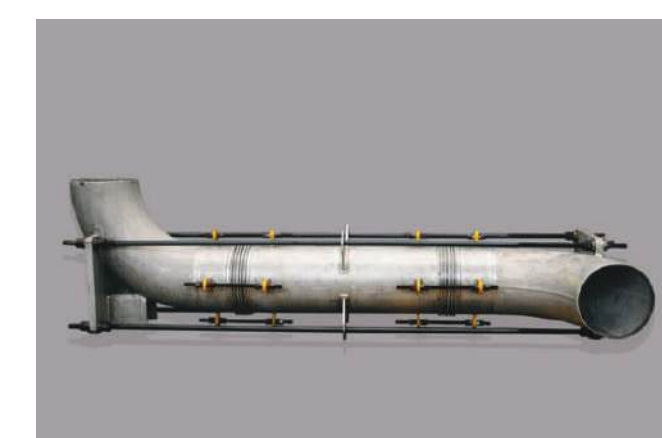

Expansion Joints



Strainers



Link Seals

## 2 Fire Fighting Systems



Fire Alarm Panel And Devices -HS 81



Gas Detectors



Flame Detectors



VESDA System



Mineral Insulated Cables



Valves- Gate Valve



Valves- Butterfly Valve



Valves- Check Valve



### 3 Process / Industrial



Butterfly Valves - Water/Sea water



Check Valves - Process Industry



Gate/Globe Valves - Water Steam



Open Gear Lubricants



Berugear HV 20

### Fabricated Products

### 4



Gratings - MS & Aluminium



Access Covers



# Instrumentation



Leading Providers of Process Instrumentation Solutions,  
At DUTCO TENNANT LLC, we are your trusted partner in providing advanced process instrumentation solutions for a wide range of industries, including water and wastewater application, water treatment, oil & gas and more. We are dedicated to providing reliable, accurate, and cost-effective solutions that meet the specific needs of our clients. With a focus on quality, innovation, and customer service, we deliver tailored instrumentation solutions that enhance process control, improve operational efficiency, and ensure compliance with industry standards.

## 1 Flow Measurement



Flanged Electromagnetic Flow Meter



Insertion Electromagnetic Flow Meter



Grooved Electromagnetic Flow Meter



Clamp-On Ultrasonic Flow Meter Wall Mount

## Level Measurement 2



Hydrostatic Level Transmitter



Ultrasonic Level Transmitter



Radar Level Transmitter



Float Level Switch



Conductive Level Switch



Level Switch Magnetic



Level Indicator



Multichannel Process Controller



### 3 Pressure Measurement



Pressure Transmitter



Remote Type Pressure Transmitter



Differential Pressure Transmitter

### Temperature Measurement 4



RTD Temperature Sensor



Temperature Transmitter



Multipoint Temperature Transmitter



Thermowell

### 5 Leak Detection



Pressure/ Flow Data Logger



Ground Microphone



lot Noise Logger



# Electrical



We specialize in providing comprehensive solutions for generation, transmission, and distribution of electrical networks across the Middle East. With decades of experience, we deliver high-quality products and services, including transformer monitoring systems, cable diagnostics, and critical components for medium and low voltage systems.

We collaborate with leading international manufacturers to provide reliable and innovative solutions, ensuring the efficiency, safety, and sustainability of electrical infrastructure.

## 1 Generation



Intego For Generator Partial Discharge Monitoring



Transformer DGA And Bushing PD & TFC (HV And MV)



Transformer Turns Ratio Meter (HV & MV)



Circuit Breaker Time Interval Meter



Circuit Breaker - Comprehensive Test Kit



Contact Resistance Meter



Cable Partial Discharge Monitoring System



Load Break/Dead Break Cable Accessories Upto 33 KV (MV)



Coupling T Surge Arrester



AP Sensing



Transformer Advanced Analytics Upto 33 KV (MV)



## Transmission

2

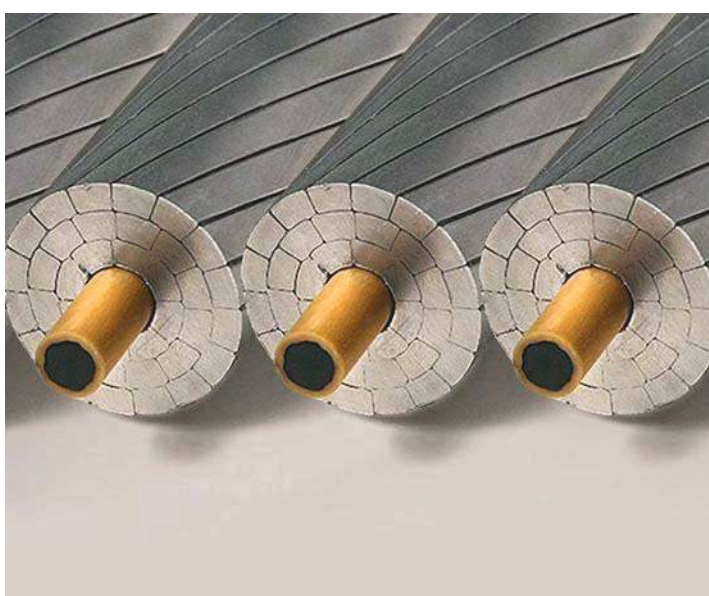

HTLS Conductor



OHTL & OPGW Fittings



Optical Ground Wire (OPGW)



OPGW Joint Box

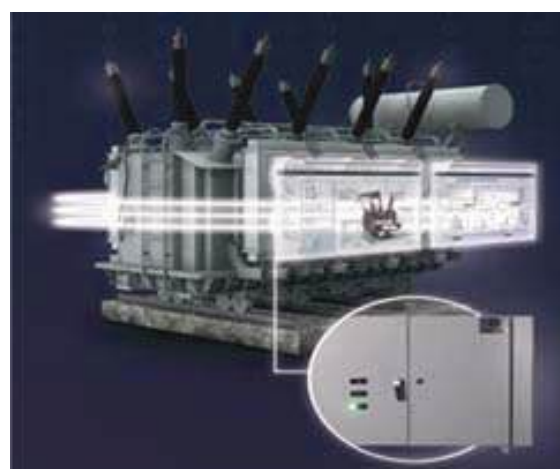

G9 Gas And Bushing PD, HEE & TFC - TOTUS (HV & MV)



AP Sensing's DAS Cable Temperature Monitoring



Substation Fittings



Cable Partial Discharge Monitoring System



Transformer Turns Ratio Meter (HV & MV)



Circuit Breaker - Comprehensive Test Kit



Contact Resistance Meter



Surge Arrester Leakage Current Analyzer

3

## Distribution



Cable Temperature Monitoring (MV)



Fuse Mate



Wooden Poles



Three Phase Electricity Meter



# Science & Technology



Science and Technology department drives societal advancement across the Middle East and beyond by enabling groundbreaking research and sustainable innovation. With expertise in spectroscopy, microscopy, and material testing, we address critical challenges in chemical and physical properties of elements, healthcare, renewable energy, and environmental preservation. Serving diverse industries and markets, we bridge scientific discovery with practical applications, empowering progress for a better global future.

## 1 Testing



ARL™ 9900  
Simultaneous-  
Sequential XRF Series



VSC® 8000/HS  
For the expert  
analysis of questioned  
documents



Extruder



walter & bai



Spectro Scientific

## Test & Measurement 2



Parametric Analyser

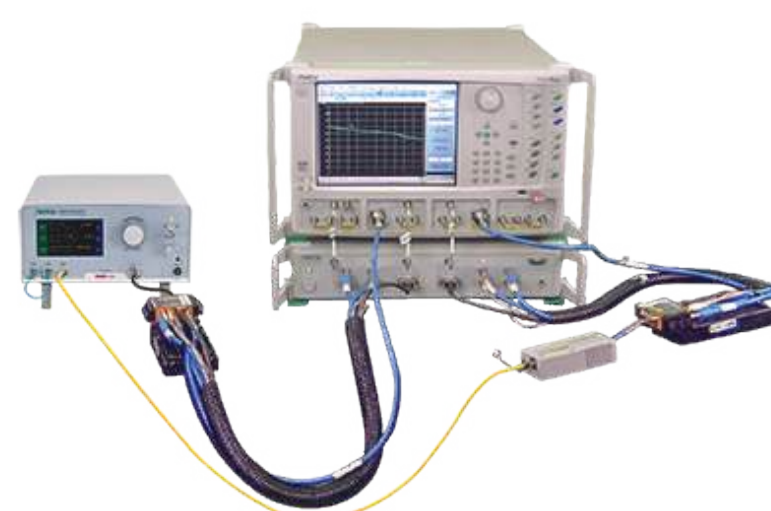

Vector Network  
analyser



Mixed Domain  
Oscilloscopes



## Research

3



TEM

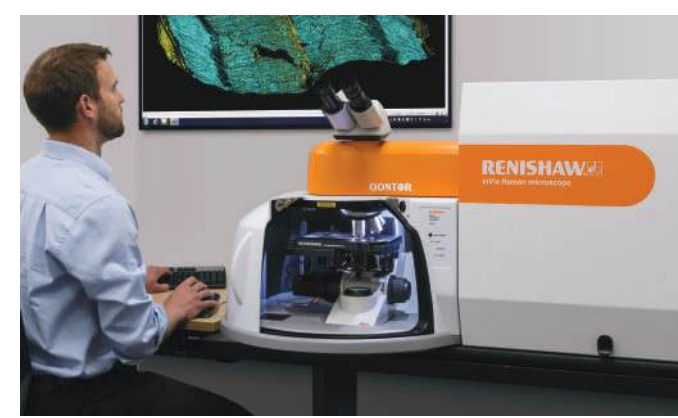

Raman Spectroscopy



Atomic Force  
Microscope

4

## Training

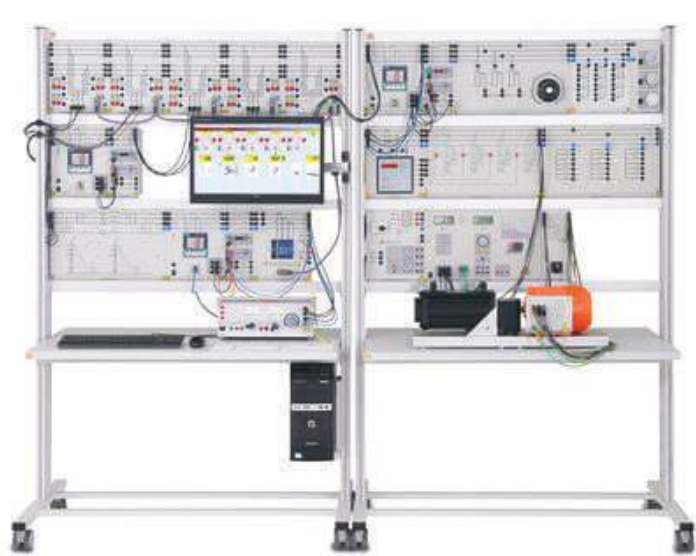

Smart Grid  
Training System



Blended Learning



Smart Factory

## Mobile Lab – Containerised Modular Solutions

5



Mobile Laboratory



# OUR PRESENCE

## Head Office

**Dutco Tennant LLC / Business Communications LLC**

 | Dutco Group Complex, Jebel Ali Industrial Zone 1 P.O. Box 233, Dubai United Arab Emirates



 | +9714-2152799

 | +9714 2236193

 | [info@dutcotennant.com](mailto:info@dutcotennant.com)

## UAE – ABU DHABI

**Dutco Tennant LLC / Business Communications Company LLC**

 | P.O. Box 2534, Abu Dhabi, UAE

 | +9712-2045111

 | +9712-6316465

 | [info@dutcotennant.com](mailto:info@dutcotennant.com)

## KSA – JEDDAH

**Dynamic Technology Supplies Co. Ltd.**

 | Wasel 7097, Jeddah 23343 – 3523, KSA

 | +966-126179573

 | +966-126179574

 | [info@dtsaudi.com](mailto:info@dtsaudi.com)

## KSA-AL- KHOBAR

**Dynamic Technology Supplies Co. Ltd.**

 | P O Box 1216, Hail Center, Rakah, KSA

 | +966 13 8570357

 | +966 13 8570349

 | [info@dtsaudi.com](mailto:info@dtsaudi.com)

## RESIDENT REPRESENTATIVE

**Dynamic Technology Supplies Co. Ltd.**

 | Riyadh, KSA

 | +966-556522021

 | +966-114778090

 | [info@dtsaudi.com](mailto:info@dtsaudi.com)

## QATAR

**Dutco Tennant Qatar WLL**

 | Po Box: 3288 Regency Business Center Building No.40, 6th Floor, Office No. 602 Street 810, Zone 18 Al Corniche Doha-Qatar

 | +974 4465 5808

 | +974 4465 7519

 | [info@dtq.qa](mailto:info@dtq.qa)

## OMAN

**Dynamic Technologies Trading SPC**

 | PO Box 57, PC 104 Bait Al Asail Building, Flat no. 23 Way No. 9214, Near to Holiday Inn Mawaleh South, Sultanate of Oman.

 | +968-24271478

 | +968-24271445

 | [info@dutcotennant.com](mailto:info@dutcotennant.com)

## BAHRAIN

**Dutco Tennant Bahrain W.L.L**

 | 52, Building 2317, Lehmedeh Building - 1, Road 2830, Block 428 Seef District, Manama Kingdom of Bahrain

 | +973-17300459

 | +973-17300549

 | [info@dutcotennant.com](mailto:info@dutcotennant.com)